

san_siro



KUSCH+CO



A name with prestige – named after the moniker of the Giuseppe Meazza stadium in Milan, which was the inspiration for one of the novel table top shapes. This extremely versatile table series opens up an almost infinite number of design and finishing options for tables and table configurations in all sizes and shapes. Either stationary on glides or mobile on castors. Its signature feature is the slender tubular steel column frame supported by flat, straight aluminium pedestals. Or the elegant wooden frame with downwardly tapering legs made of solid beech, which are screwed to the top via metal brackets.



Content

Variations	6
Product data	11
Materials	20
Fire Prevention, quality, sustainability	21
References	22



Design by Norbert Geelen

After having completed his training as industrial designer at the University of Essen, he started freelancing at the Italian Studio Matteo Thun in Milan. Together with his partner Robert Kilders, he founded the design studio bert&bert in 1997. Since 2005, Norbert Geelen feels at home both in his German office in Straelen and in his Milan studio. He has specialised in designing upmarket lifestyle products and furniture.





Variations

san_siro rectangular table with metal frame

The rectangular tables with the slender tubular steel column frame are available with a small or large T pedestal, depending on the table top size.



san_siro square / pebble-shaped / round table with metal frame

The central cross pedestal of this compact-sized table is as elegant as it is stable, and can be combined with square, pebble shaped and round table tops.



san_siro square bar table with metal frame

The square bar table features a cross frame as well as a higher column, ideally suited for receptions.



san_siro rectangular folding table, horizontally stackable, with metal frame

When equipped with castors, the san_siro folding tables become mobile. They are designed for multifunctional uses in offices, training classrooms, and meeting and conference rooms.



Variations

san_siro rectangular folding table, horizontally stackable, with metal frame

These tables can be nested together for space-saving storage. If the rectangular table top is swivelled into a vertical position, the pedestals automatically turn inwards by about 30° for optimum nesting. With a small overhang on the short sides, the table offers maximum space on the long sides. With the large overhang, it is possible to sit at the head of the table with plenty of legroom.



san_siro square / rectangular / stadium-shaped / pebble-shaped / round occasional table with wooden frame

The solid beech legs blend into the elegant metal brackets, and are as such individually screwed into the table top. Available in many different dimensions and shapes, resulting in a slender look.



san_siro square / rectangular / pebble-shaped / round occasional table with wooden frame

The line-up also includes an occasional table. Available with square, rectangular, pebble or round table tops.





Product data

san_siro rectangular table with metal frame

SAN SIRO MEETING TABLE

T-LEG RC 1

Rectangular table

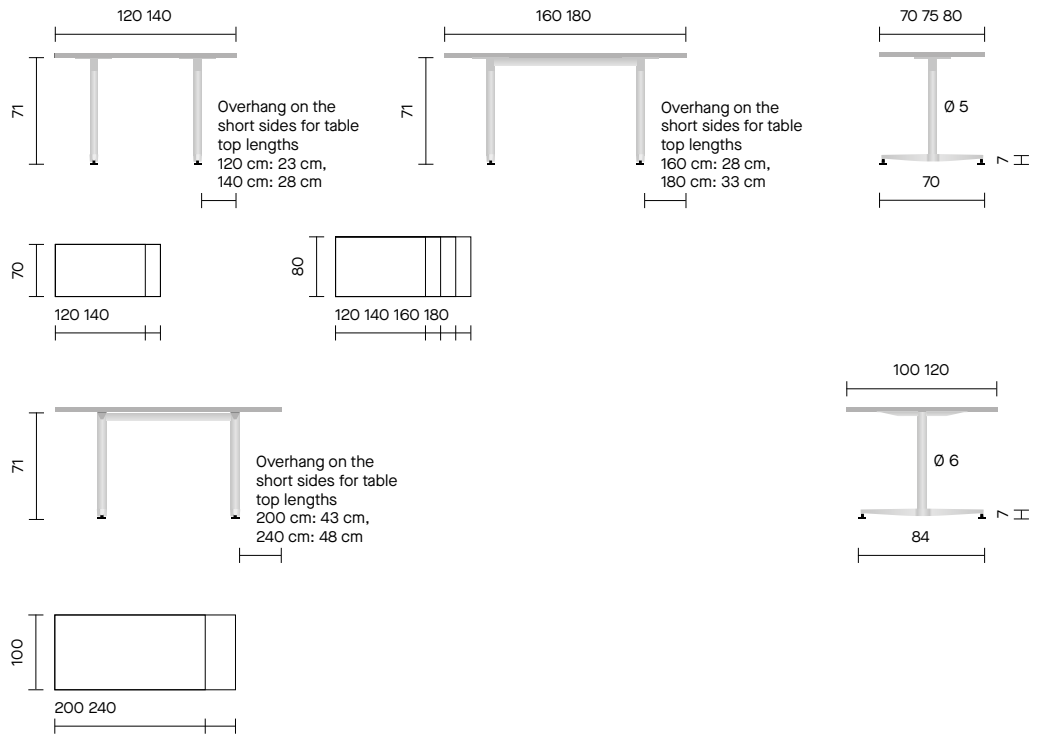

Accessories

- Plastic glides
- Plastic glides, nonskid
- Plastic glides with felt
- Modesty panels
- Linking elements table/table

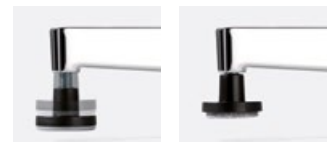

Product data

san_siro square / pebble-shaped / round table with metal frame

SAN SIRO MEETING TABLE

4A SQ

Square table

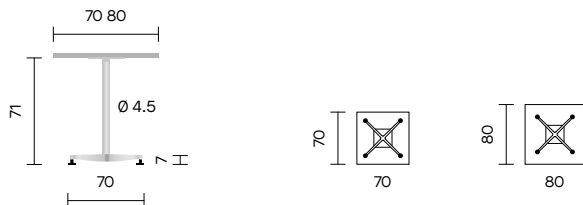

SAN SIRO MEETING TABLE

4A PES

Pebble shaped table

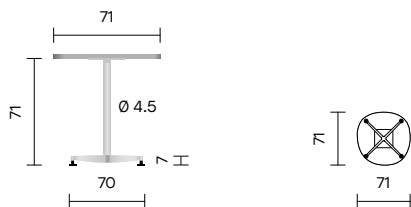

SAN SIRO MEETING TABLE

4A RD 1

Round table

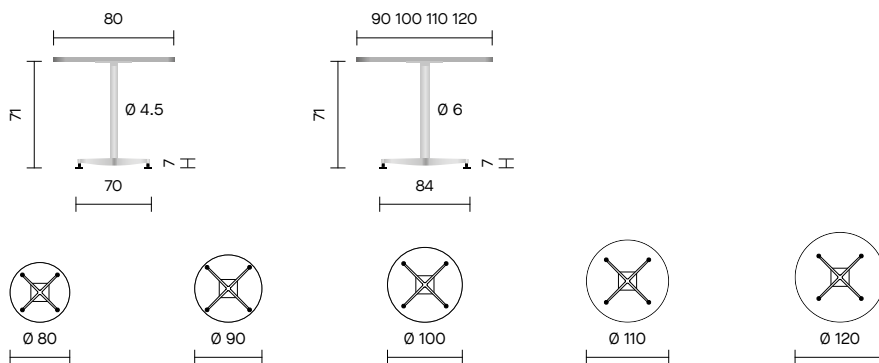

san_siro square bar table with metal frame

SAN SIRO MEETING TABLE

4A SQ

Square bar table

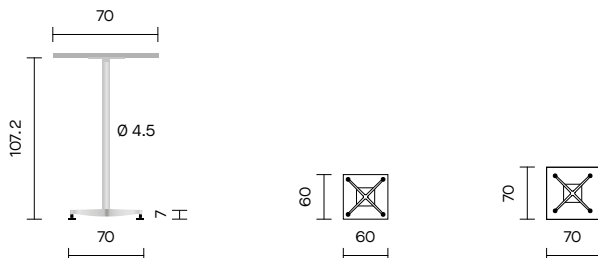

san_siro square / pebble-shaped / round table with metal frame / san_siro square bar table with metal frame

Accessories

- Plastic glides
- Plastic glides, nonskid
- Plastic glides with felt



Dimensions in cm

san_siro rectangular folding table, horizontally stackable, with metal frame

SAN SIRO MEETING TABLE

T-LEG TF RC 1

Rectangular folding table, horizontally stackable

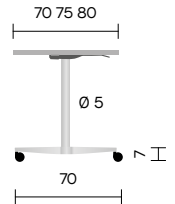
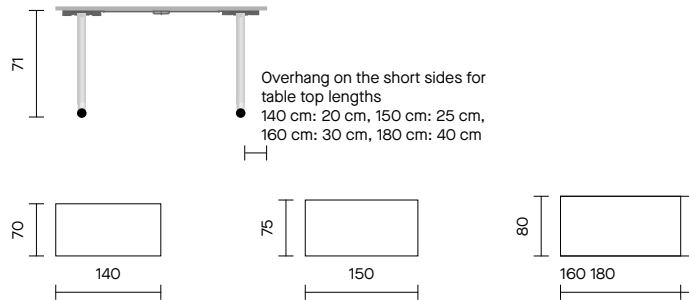

Handling

- Manually operated with one hand
- Mechanism automatically locks into place when the table top is in a horizontal position
- The horizontal table top is securely locked into place, no accidental flipping back
- Flat release mechanism
- Wear- and maintenance-free mechanism
- Folding and nesting with mounted modesty panel
- Unvarying distance between two nested tables, even with modesty panel
- It is possible to sit at the head of the table
- Lockable castors

Safety

- Automatic, synchronised locking mechanism for table top when in a horizontal position
- It is not possible to operate or release the mechanism when weight is on the table top
- The mechanism is neither self-actuating nor can it be released accidentally
- No visible locking hooks or pinch points
- Passed stability testing
- GS mark for tested product safety

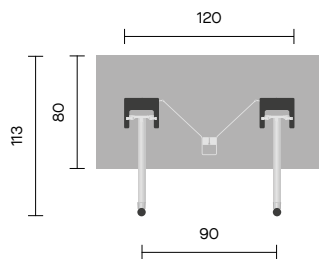
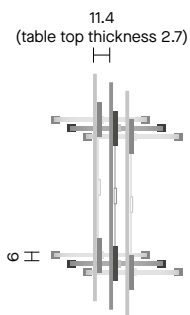

Accessories

- Black castors, 2 can be locked
- Black castors with chrome-plated ring, 2 can be locked
- Modesty panels
- Linking elements table/table



Product data

san_siro rectangular folding table, horizontally stackable, with metal frame

SAN SIRO MEETING TABLE

T-LEG TF RC 2

Rectangular folding table,
horizontally stackable:
small overhang on the short sides



Overhang on short sides for
table top lengths
140 cm: 3 cm, 150 cm: 9 cm,
160 cm: 3 cm

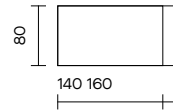
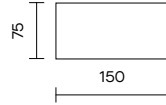
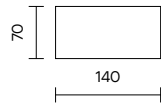
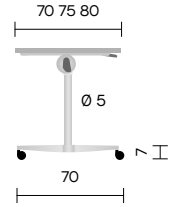

Horizontal stackability

Small pedestals
(foot)

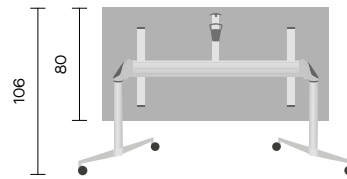
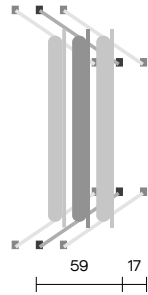

san_siro rectangular folding table, horizontally stackable, with metal frame

SAN SIRO MEETING TABLE

T-LEG TF RC 3

Rectangular folding table,
horizontally stackable:
large overhang on short sides

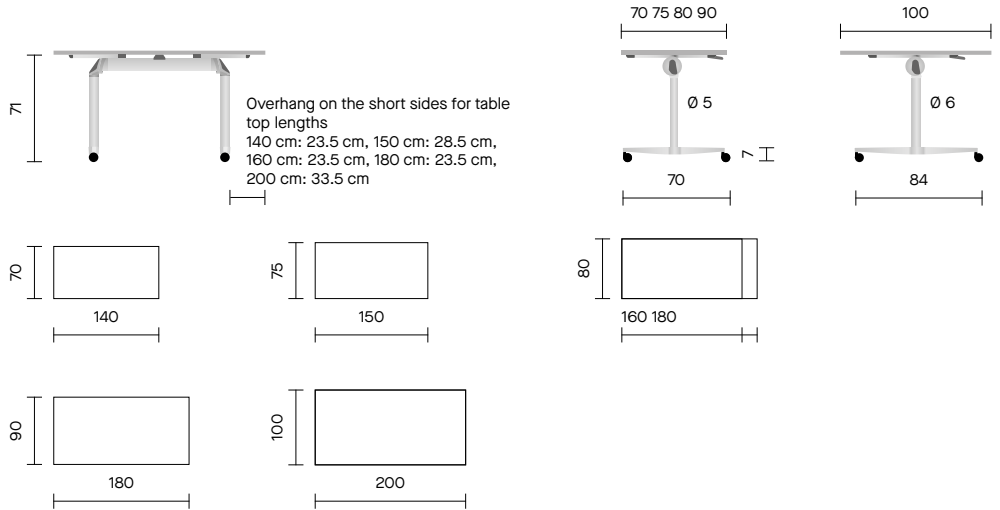

Horizontal stackability

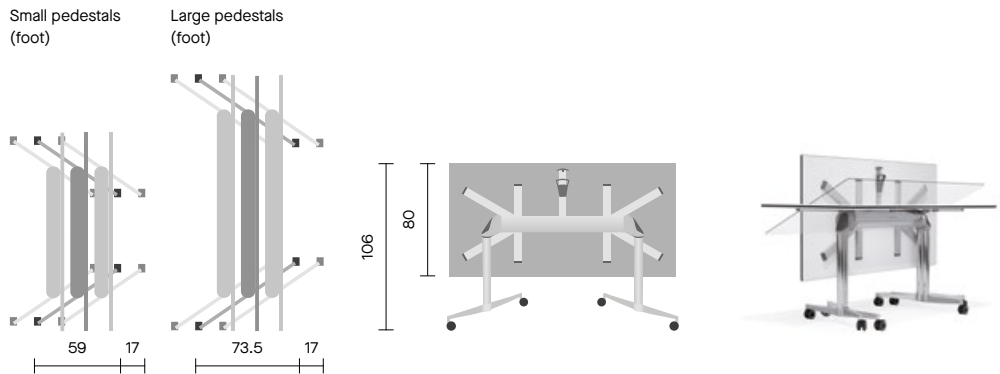

Accessories

- Black castors, 2 can be locked
- Black castors with chrome-plated ring, 2 can be locked
- Modesty panels
- Linking elements table/table



Product data

san_siro square/rectangular/stadium-shaped/pebble-shaped/round occasional table with wooden frame

SAN SIRO MEETING TABLE

LWM SQ

Square table

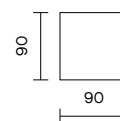
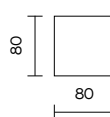
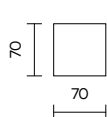
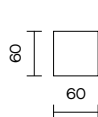
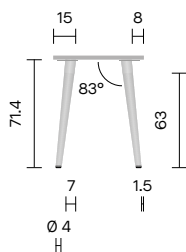

SAN SIRO MEETING TABLE

LWM RC

Rectangular table

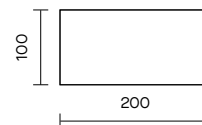
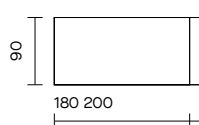
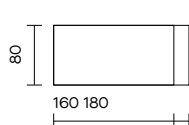
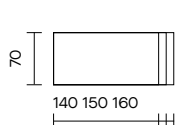

Table tops longer than 150 cm with an extra reinforcing bar

SAN SIRO MEETING TABLE

LWM STS

Stadium shaped table

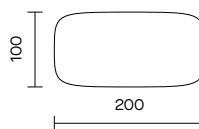
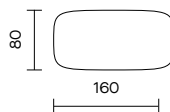
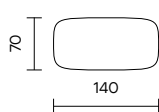

Table tops longer than 150 cm with an extra reinforcing bar

san_siro square / rectangular / stadium-shaped / pebble-shaped / round occasional table with wooden frame

SAN SIRO MEETING TABLE

LWM PES

Pebble shaped table

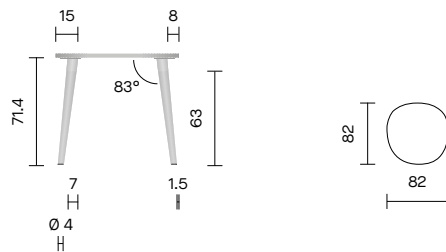

SAN SIRO MEETING TABLE

LWM RD

Round table

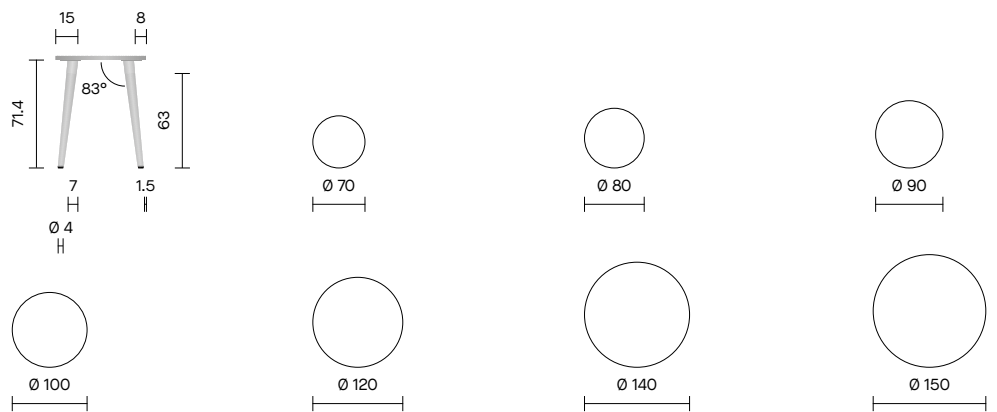

Table tops larger than Ø 140 cm with an extra reinforcing bar

Accessories

- Plastic glides
- Metal glides
- Plastic glides with felt
- Modesty panels (for rectangular tables SAN SIRO MEETING TABLE LWM RC)
- Linking table/table (for tables SAN SIRO MEETING TABLE LWM RC)
- Power and data modules (media port) (for rectangular tables SAN SIRO MEETING TABLE LWM RC and stadium shaped tables SAN SIRO MEETING TABLE LWM STS)



Product data

san_siro square / rectangular / pebble-shaped / round occasional table with wooden frame

SAN SIRO TABLE LWM SQ

Square occasional table

SAN SIRO TABLE LWM RC

Rectangular occasional table

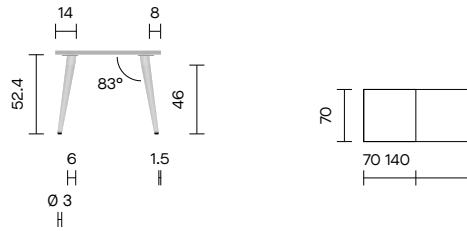

SAN SIRO TABLE LWM PES

Pebble shaped occasional table

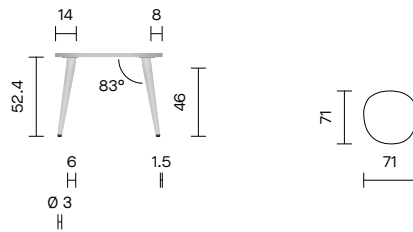

6SAN SIRO TABLE LWM RD

Round occasional table

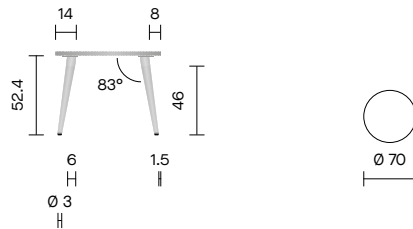

Accessories

- Plastic glides
- Metal glides
- Plastic glides with felt
- Protect glides



san_siro table configurations

Apart from the stand-alone tables, table series san_siro is available in a multitude of standard-issue table configurations with metal frames for up to 24 persons.

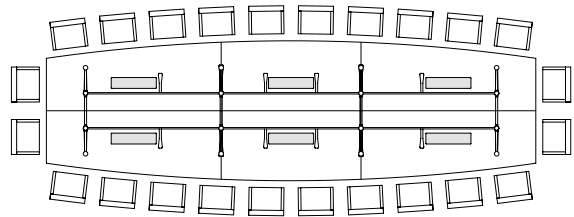
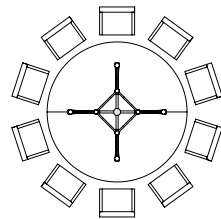
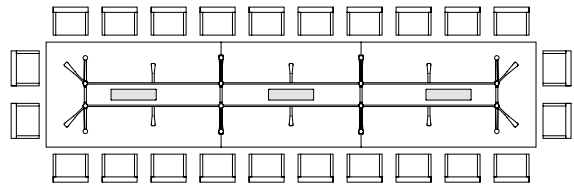

Materials

san_siro

Metal frame

- Powder coated, chromed or satin chromed steel columns
- Powder coated or polished aluminium pedestals (foot)
- The size of the pedestals (foot) is dependent on the table top size

- Casing for mechanism anodised aluminium (for tables SAN SIRO MEETING TABLE T-LEG TF RC 2, SAN SIRO MEETING TABLE T-LEG TF RC 3)
- RAL 9006 white aluminium powder coated aluminium sliding disks (for tables SAN SIRO MEETING TABLE T-LEG TF RC 2, SAN SIRO MEETING TABLE T-LEG TF RC 3)

Wooden frame

- Legs natural beech or stained
- Optional legs natural oak
- Brackets powder coated

Type of edge



2 mm
plastic ABS



2 mm
plastic ABS with protective edge



2 mm
natural wood

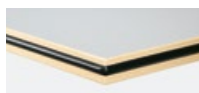

2 mm
natural wood with protective edge



2 mm*
plastic ABS on MDF, 50 mm
chamfered lipping



2 mm*
plastic ABS on MDF,
50 mm chamfered lipping
on 2 sides



1 mm
plastic PP



1 mm*
plastic PP on MDF, 50 mm
chamfered lipping on 2
sides



* only for tables with metal frame

Fire Prevention, quality, sustainability

Excerpt

Fire Prevention

Depending on the environment, contract seating has to be able to fulfil very specific requirements. Interior designers and planners sometimes have to clear difficult hurdles: such as exacting fire prevention regulations. Kusch+Co has worked out individual solutions:

Wooden parts

As standard, wooden parts as well as high-grade wooden veneer finishes and high-grade wooden veneer edges are protected by a UV curing, environmentally harmless, water-based lacquer meeting all the requirements of "low flammability" acc. to DIN EN 13501 B s2 d0.

Table tops

Table tops with a 3-layered chipboard core, and featuring either a HPL or real wood veneer surface are project-related also available in a low flammability finish.

Please contact us if you wish to receive the test reports.

Please contact us to receive further information.

Quality

Our environmental and quality management systems are certified acc. to DIN EN ISO 14001:2015 and to DIN EN ISO 9001:2015. External audits as well as our in-house laboratory safeguard our quality level.

The tables of series san_siro meet the requirements with regard to stability, static and dynamic load as well as strength and durability in compliance with the current European Directives, standards and regulations.

On top of this, we voluntarily test the strength of our table frames with an additional horizontal load test using higher weights and more test cycles.

To equip our tables, folding tables and table configurations with power and data modules, we use high-quality components made by various manufacturers that have tested their products in accordance with VDE guidelines and the following EU directives:

- Electromagnetic Compatibility Directive 2014/30/EU
- Low Voltage Directive 2014/35/EU
- RoHS3 (Restriction of Hazardous Substances) Directive 2015/863/EU

All of our professionally installed wiring, plugs and netboxes once again undergo electrical testing at our plant and are then labelled and documented as having done so in accordance with DIN EN 50699 VDE 0702: 2016. They are then given a seal of approval and a CE declaration of conformity in accordance with the German Product Safety Act (ProdSG).

We are certified in compliance with DIN EN ISO 9001:2015. In our own laboratory, we test our products before their market launch whether they comply with the normative requirements applicable to contract seating, task chairs, and tables, and issue a Declaration of Conformity.

We happily make these Declarations of Conformity as well as our brochure "Mission Statement Quality" providing detailed information on our test procedures available to you – please contact us.



Sustainability

Kusch+Co products stand for long life cycles and optimum recyclability. From the first design drafts of a new product, we take all environmental-relevant components and production processes into consideration, ranging from the materials selection and the design all the way to the manufacturing processes which also contribute towards our sustainable energy balance.

References

Excerpt

Austria

- Banking house Carl Spängler & Co. plc, Salzburg
- Webster Vienna Private University

Belgium

- General Hospital Groeninge, Kortrijk
- General Hospital Nikolaas, Campus Beveren
- General Hospital Sint-Maarten, Mechelen
- General Hospital Zeno, Campus Knokke-Heist
- Public Centre for Social Welfare Wommelgem
- Residential care and nursing home Avondzegen, Eeklo
- Residential care and nursing home De Gerda, Sint-Niklaas
- Residential care and nursing home De Ril, Middelkerke
- Residential care and nursing home De Vlinder, Harelbeke
- Residential care and nursing home De Zathe, Nieuwpoort
- Residential care and nursing home Sint-Anna, Herentals
- Residential care and nursing home Sint-Elisabeth, Ostend
- Residential care and nursing home St. Jozef, Sint-Pauwels
- Residential care and nursing home Ter Durme, Lokeren
- St. Jozef Hospital, Campus Bornem

Cyprus

- PwC Central, Nicosia

Denmark

- Sundhedshus Nørrebro, Copenhagen

France

- Liebherr-France SAS, Colmar

Germany

- Aramark GmbH Refreshment Services, Gerlingen
- City Hall Gütersloh
- CSL Behring GmbH, Marburg
- Deutsche Bahn AG, Silver Tower, Frankfurt am Main
- District Hall of Rhein-Sieg-Kreis, Siegburg

- Division of Student Affairs Berlin
- Fressnapf Tiernahrungs GmbH, Krefeld
- German Aviation Association (BDL), Berlin
- Helios Park Hospital, Leipzig
- Lebenshilfe im Nürnberger Land (Association of People with Disabilities), Altdorf
- Lucky Bike, Bielefeld
- Musterring, Rheda-Wiedenbrück
- Protestant University Berlin
- Rotonda Business-Club GmbH & Co. KG, Cologne
- Sal's Kitchen, Cologne
- Silva Deutschland GmbH, Stuttgart
- St. Antonius-Hospital Gronau
- Steverbett-Hotel, Lüdinghausen
- Theegarten-Pactec GmbH & Co. KG, Dresden
- University Hospital Cologne
- VDA – German Association of the Automotive Industry, Berlin
- VKKD Augusta Hospital, Düsseldorf
- Volksbank Rhein-Ruhr eG, Duisburg
- Zalando SE, Berlin
- Zeppelin GmbH, Friedrichshafen

Ireland

- Ernst & Young Global Limited, Dublin

Netherlands

- Museon (Museum), The Hague
- St. Martin Hospital, Nijmegen
- University of Utrecht

Saudi Arabia

- Mouwasat Hospital, Riyadh

United Kingdom

- Dana Petroleum plc, Aberdeen
- Ealing Hospital, Southall
- Ernst & Young, London
- Generator Hostel, London
- HPI Chancery Court Hotel, London
- Royal Bank of Canada, London

USA

- Biotrial Inc., New York
- Hunter College, New York
- JPMorgan Chase Bank, New York
- Novartis, Edison











Residential care and nursing home De Vlinder, Harelbeke



Residential care and nursing home De Zathe, Nieuwpoort











Residential care and nursing home De Vlinder, Harelbeke



Residential care and nursing home Ter Durme, Lokeren









Residential care and nursing home De Ril, Middelkerke

