

creva desk

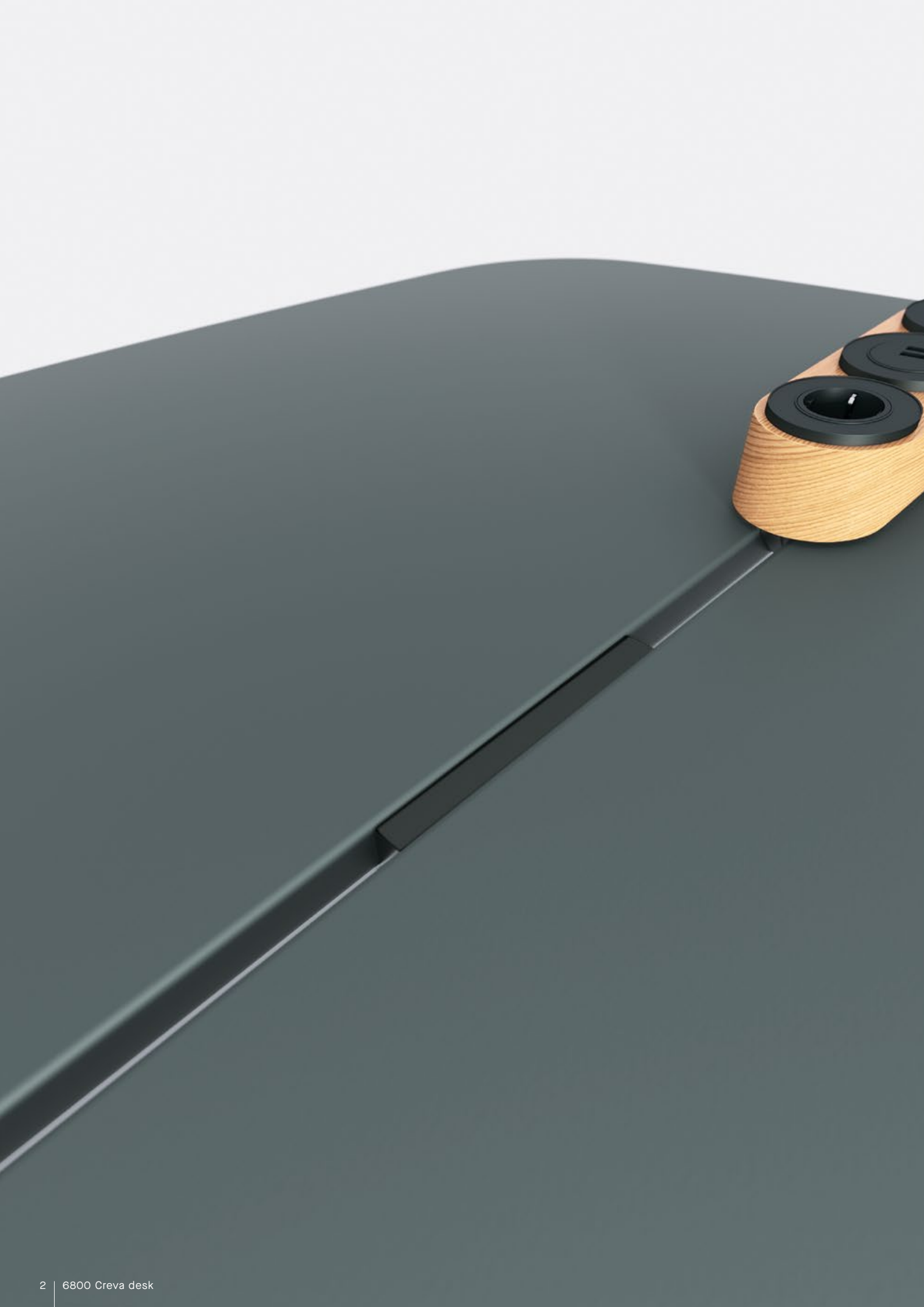

KUSCH+CO
by Nowy Styl



Creva desk – an extraordinary table series that succeeds in transposing the design aesthetics of home furniture to the office environments. Its minimalist design language is typified by round shapes and well-balanced proportions. The materiality of the natural material wood reinforces this aura. A multitude of ingenious features is incorporated into the table construction. The rail-free substructure offers plenty of legroom. The steel leg mountings with aluminium supporting beams combined with the steel lateral bars guarantee the best possible stability. The central joint in the table top can hold a variety of freely positionable power modules, view protection panels and trays. Creva desk excels in versatility – ideally suited for either individual workstations or large-scale conference configurations, not forgetting the high tables. Geared towards a plethora of environments, from offices to staff restaurants and cafeterias, from recreation rooms to waiting areas, from meeting points to break-out areas.



Content

| | |
|--|----|
| Variations | 10 |
| Product data | 16 |
| Materials, finishes | 31 |
| Fire Prevention, quality, sustainability | 34 |



Design by kaschkasch

In 2011, Florian Kallus and Sebastian Schneider founded their own design studio. This duo focuses their creative energy on product design & art direction. In co-operation with companies like Kusch+Co, they create classical and modular furniture designs, characterised by a synthesis of innovation, functionality and aesthetics.











KUSCHCO



Variations

6850 Square / rectangular table / 6855 Curved rectangle table, without top joint

An exceptional wide spectrum of tables geared towards a plethora of environments. Available with a square table top measuring 150 × 150 cm. Either rectangular or curved rectangle table tops in a variety of widths up to 180 cm and lengths up to 360 cm resp. 420 cm. All table variations come with ample overhang on the sides, offering plenty of legroom.



6850/6



6850/6



6855/6

6870 Round table, without top joint

The round table is available with two table top sizes, either with a 120 cm or a 150 cm diameter. Featuring a large overhang on all sides.



6870/6

6860 Rectangular high table / 6865 Curved rectangle high table, without top joint

The high table has become a favourite meeting point. Either for a spontaneous exchange of ideas while standing or a short meeting on the bar stools with matching design aesthetics. Available either with a rectangular or a curved rectangular table top measuring 100 cm resp. 110 cm in width and 200 cm in length.



6860/6



6865/6

6880 Rectangular table / 6885 Curved rectangle table, with top joint

A multifunctional table geared towards a plethora of environments. The central joint is designed to hold a variety of power modules, view protection panels and trays. Available with either rectangular or curved rectangle table tops in a wide variety of widths up to 180 cm and lengths up to 360 cm resp. 420 cm. All table variations come with ample overhang on the sides, offering plenty of legroom.



6880/6



6885/6

6890 Rectangular high table / 6895 Curved rectangle high table, with top joint

The high table variation excels in functionality through the central joint combined with the optional extras. Ideally suited for work, either while standing or sitting on a bar stool. Available either with a rectangular or a curved rectangle table top measuring 100 cm resp. 110 cm in width and 200 cm in length.



6890/6



6895/6









Product data

6800 Creva desk, without top joint

6850/6

Square table,
without top joint

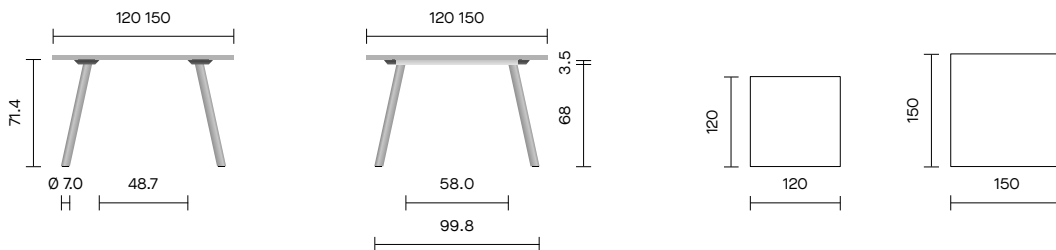

6850/6

Rectangular table,
without top joint

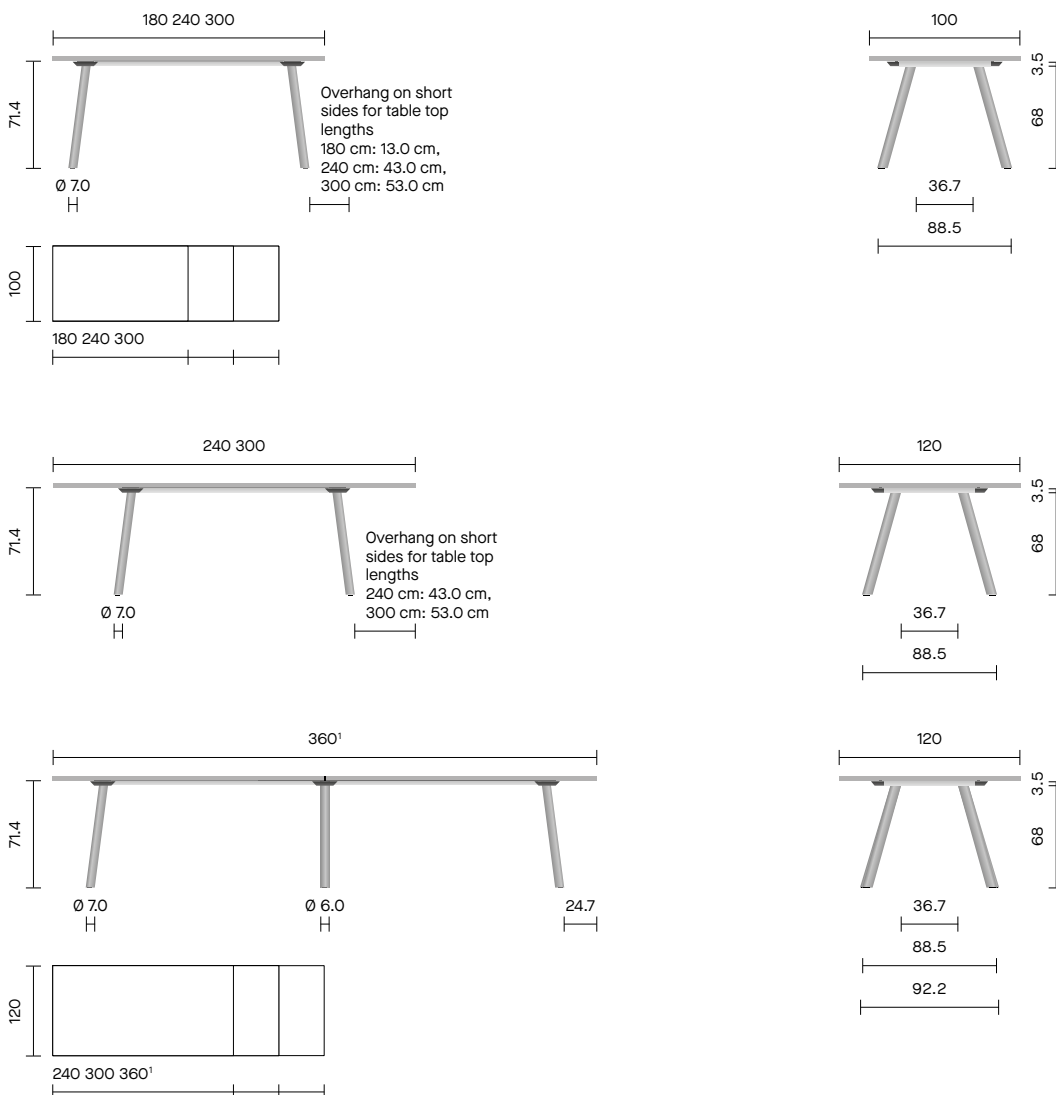

¹ Top in two parts

² Top in four parts

Dimensions in cm

6800 Creva desk, without top joint

6850/6

Rectangular table,
without top joint

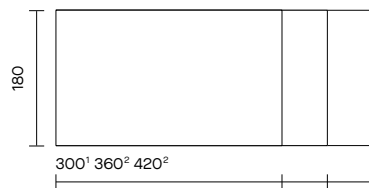
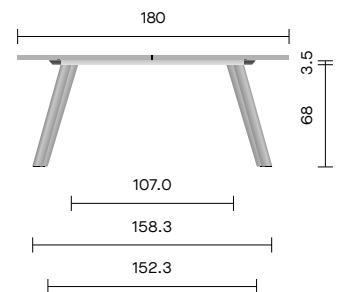
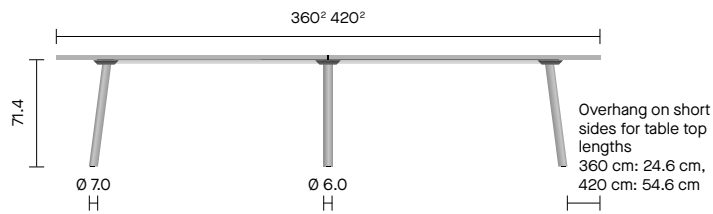
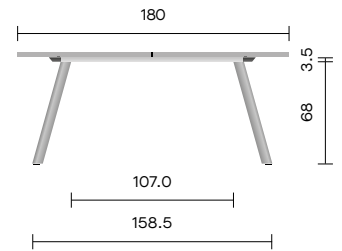
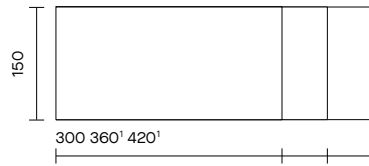
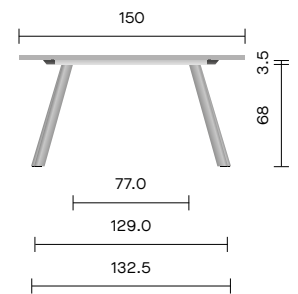
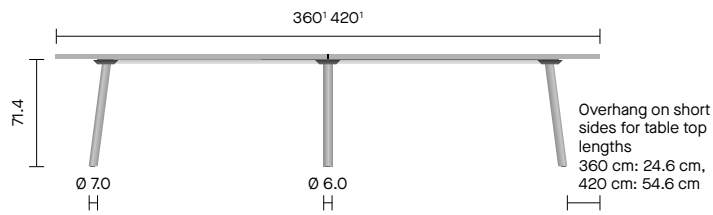
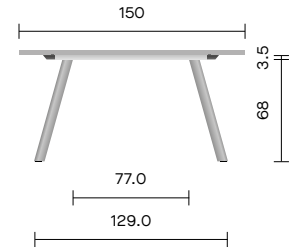
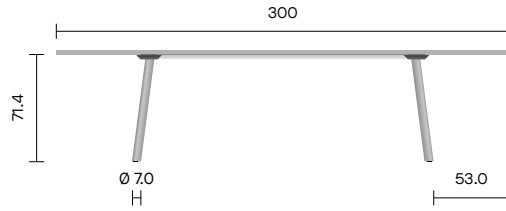

Product data

6800 Creva desk, without top joint

6870/6

Round table,
without top joint

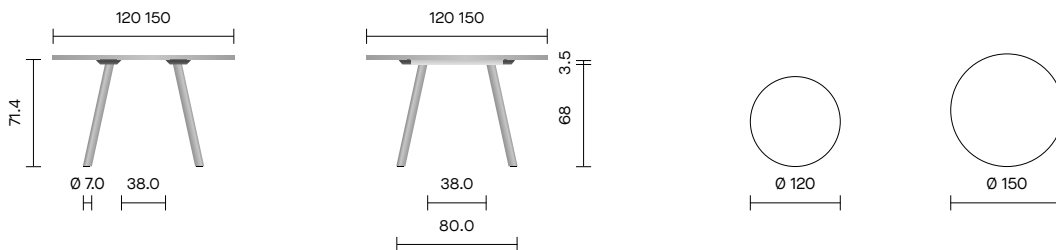

6855/6

Curved rectangle table,
without top joint

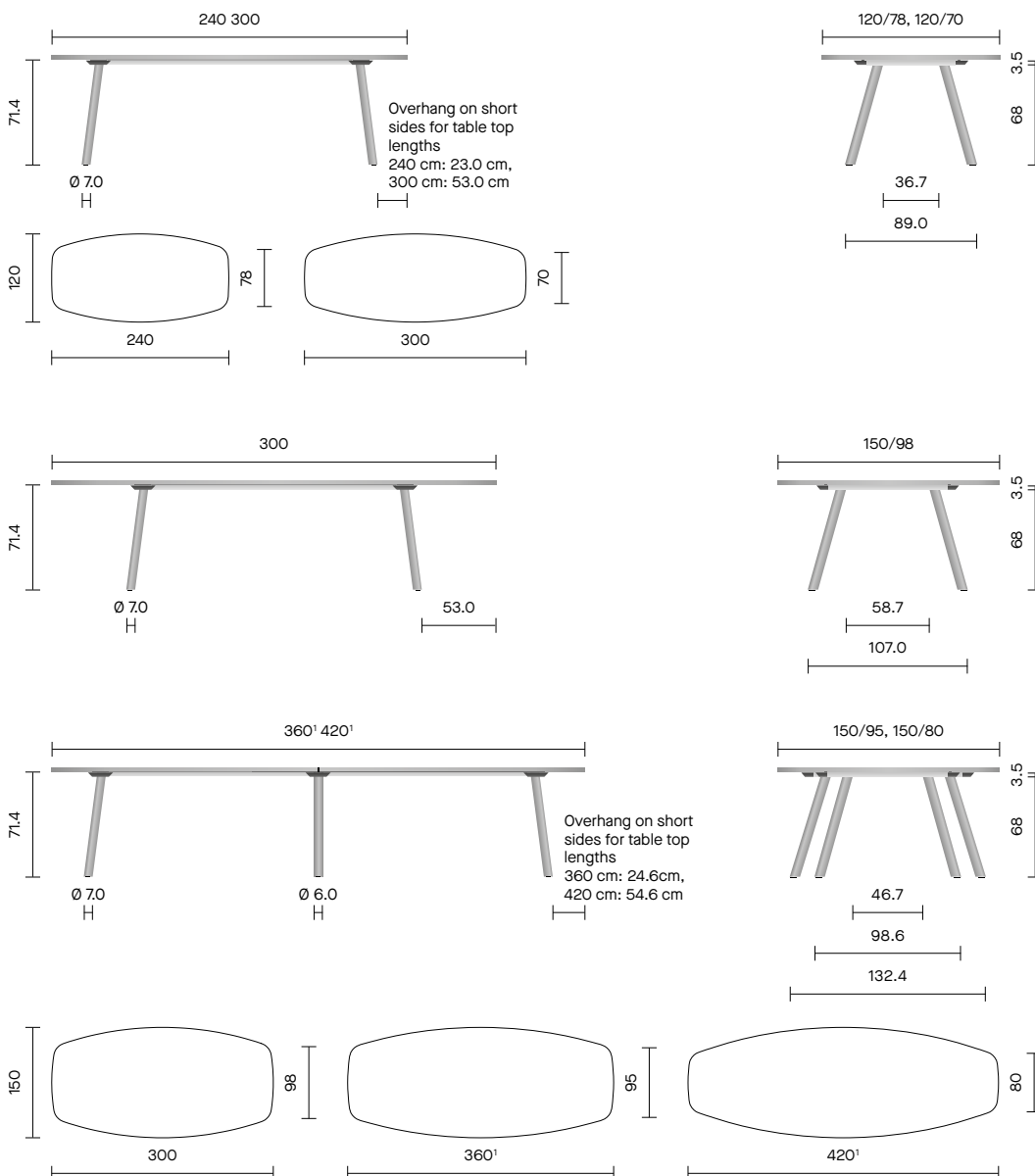

¹ Top in two parts

² Top in four parts

Dimensions in cm

6800 Creva desk, without top joint

6855/6

Curved rectangle table, without top joint

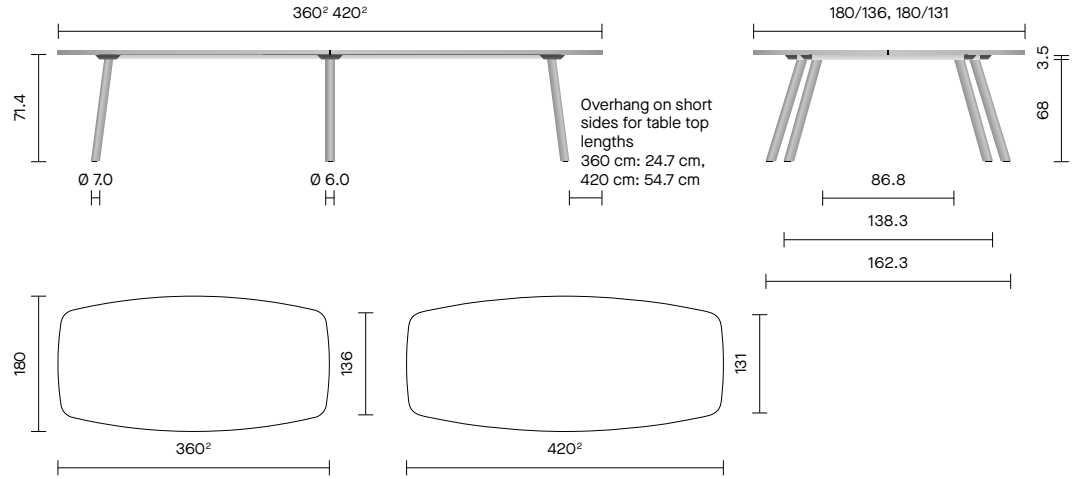

6860/6

Rectangular high table, without top joint

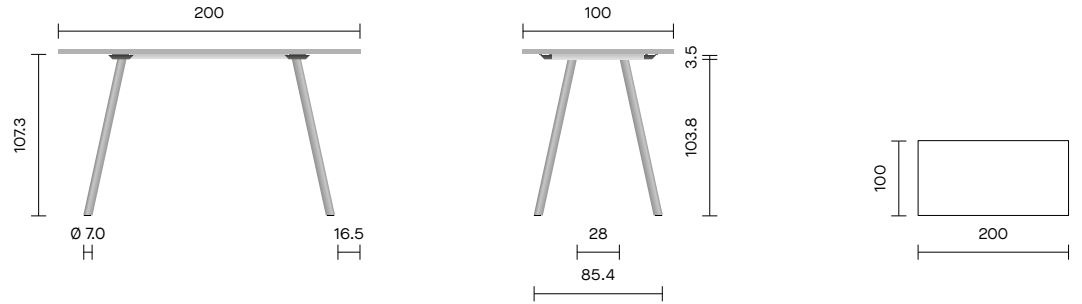

Product data

6800 Creva desk, without top joint

6865/6

Curved rectangle high table,
without top joint

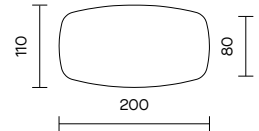
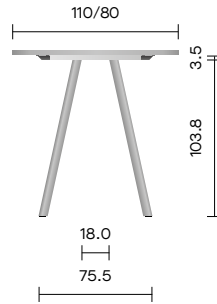
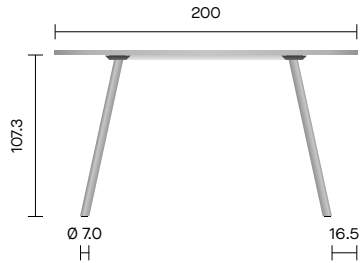

Table tops

D **E** **J** **K**

Lippings

1 **2** **6** **8** **30** **31**

Accessories

- Plastic glides
- Felt glides
- Centrally positioned power and data modules
- Cable duct, anthracite felt
- 1 leg for power and data with power cable

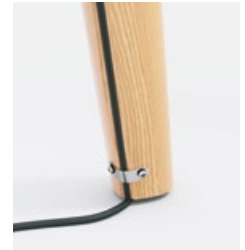







Product data

6800 Creva desk, with top joint

6880/6

Rectangular table,
with top joint

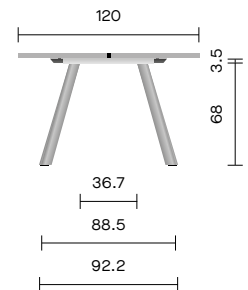
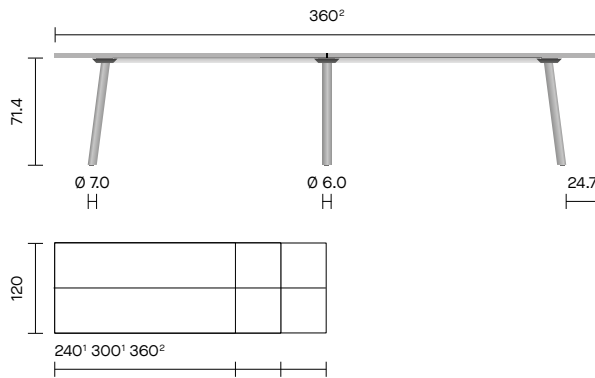
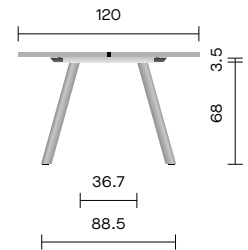
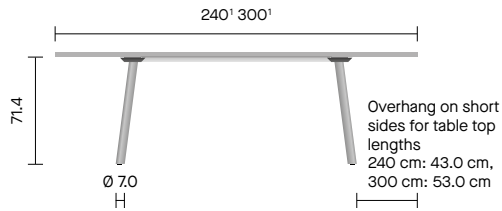
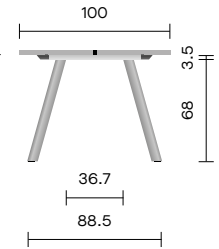
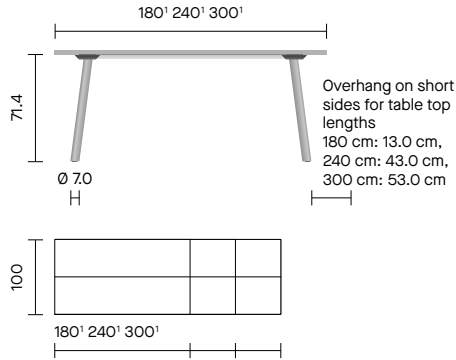

¹ Top in two parts
² Top in four parts

Dimensions in cm

6800 Creva desk, with top joint

6880/6

Rectangular table, with top joint

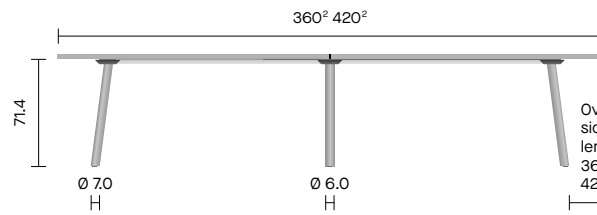
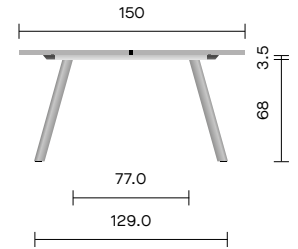
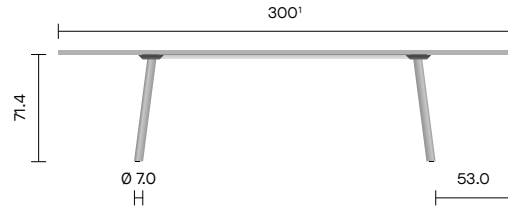

Overhang on short sides for table top lengths
 360 cm: 24.6 cm,
 420 cm: 54.6 cm

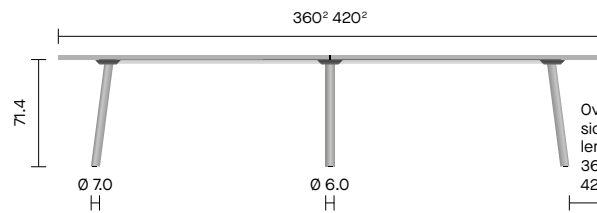
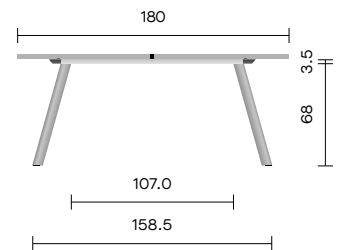
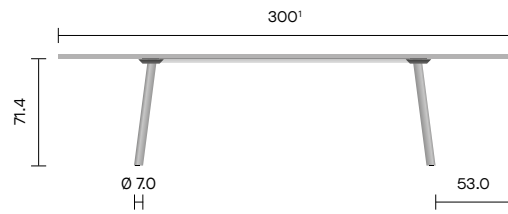
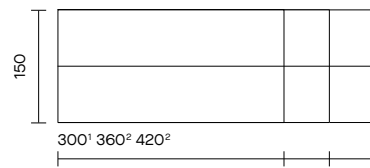
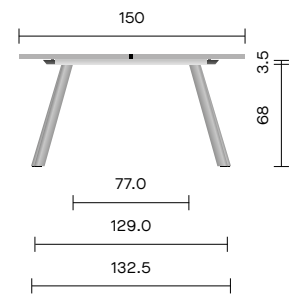

Overhang on short sides for table top lengths
 360 cm: 24.6 cm,
 420 cm: 54.6 cm

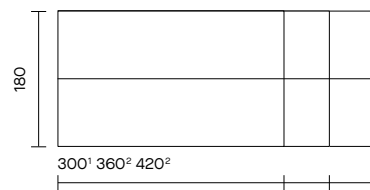
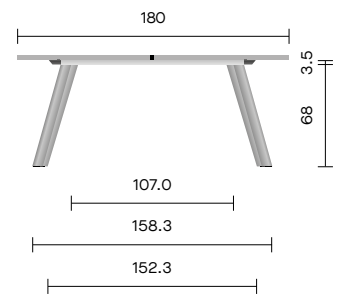

Product data

6800 Creva desk, with top joint

6885/6

Curved rectangle table, with top joint

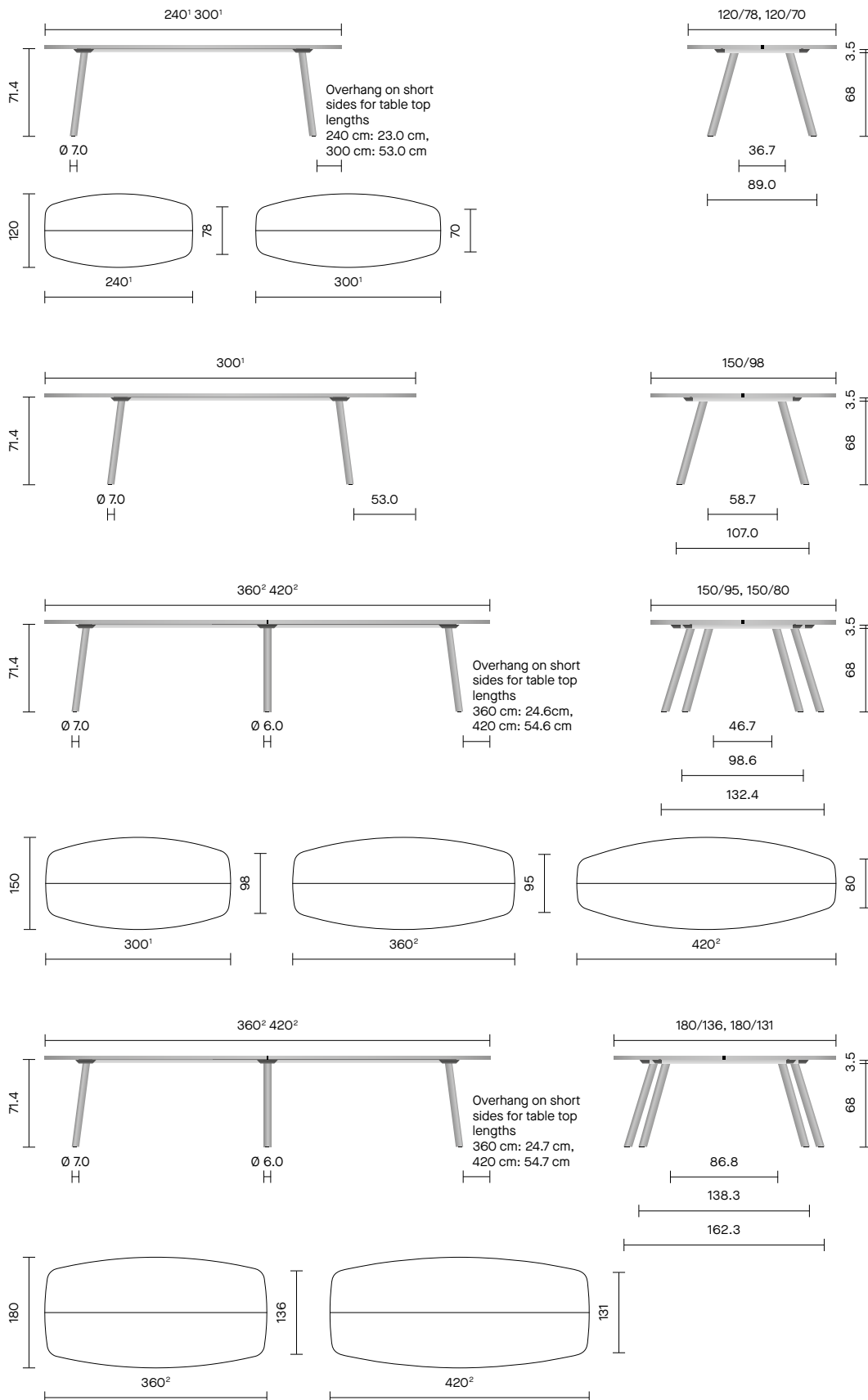

¹ Top in two parts

² Top in four parts

Dimensions in cm

6800 Creva desk, with top joint

6890/6

Rectangular high table,
with top joint

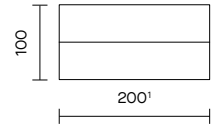
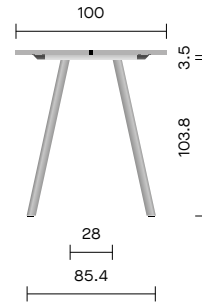
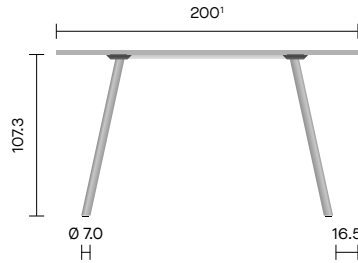

6895/6

Curved rectangle high table,
with top joint

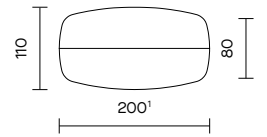
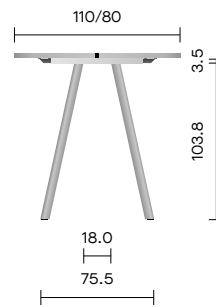
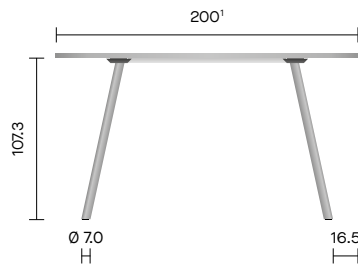

Table tops

D **E** **J** **K**

Lippings

1 **2** **6** **8** **30** **31**

Accessories

- Plastic glides
- Felt glides
- View protection panel
- Tray







shaping the way we sit

Product data

6800 Creva desk, with top joint

Power and data

- Power and data box for 1 insert
 - 1 insert country-specific power socketor
 - 1 insert dual USB charger
- Power and data box for 2 inserts
 - 2 inserts country-specific power socketor
 - 2 inserts dual USB chargeror
 - 1 insert country-specific power socket, 1 insert dual USB charger
- Power and data box for 3 inserts
 - 3 inserts country-specific power socketor
 - 3 inserts dual USB chargeror
 - 2 inserts country-specific power socket, 1 insert dual USB chargeror
 - 1 insert country-specific power socket, 2 inserts dual USB charger
- Cable duct, anthracite felt
- 1 leg for power and data with power cable

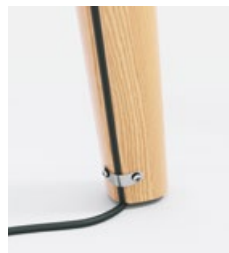

6800 Creva desk

Curved rectangle tables

In order to measure the widths on the short sides, we measure the table top as if it didn't have rounded edges.



Materials, finishes

6800 Creva desk

Legs, aluminium supporting beams

- Legs natural beech or stained acc. to standard collection
- Leg mountings RAL 9006 white aluminium powder coated
- Aluminium supporting beams anodised mat silver
- Black plastic closing caps

Power and data

- Cable duct, anthracite felt
- Leg for power and data, natural beech or stained acc. to standard collection
- Power and data box, natural beech or stained acc. to standard collection (for tables with top joint)



Accessories (for tables with top joint)

- View protection panel, entirely upholstered, fabric from standard collection (not available in the material leather)
- Tray, natural beech or stained acc. to standard collection

Beech stains K



Beech stains S



* Not available for beech and maple veneer.

Oak stains K



Closed porous veneer tops



Open porous veneer tops



Powder coating

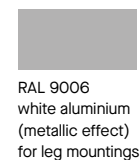

Materials, finishes

Laminate HPL Resopal® Antibacterial

RESOPAL

Available decor sizes laminate HPL Resopal Antibacterial
HPL = High Pressure Laminate



300 x 150 cm
High pressure laminated tops HPL Resopal frosty white, alabaster, shadow nut and north sea.

300 x 130 cm
High pressure laminated tops HPL Resopal pearl white, maple, global beech, sol oak, silver grey, soft grey and ebony.



210 x 130 cm
Low flammability high pressure laminated tops HPL Resopal global beech and silver grey. Other colours are available on request for larger orders.



frosty white
1573-60



pearl white
0105-60



alabaster
D 431-60



maple
4230-60



global beech
4306-60¹



sol oak
4176-60



shadow nut
4079-60

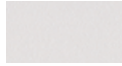

silver grey
0160-60^{1,3}



soft grey
1500N-60



north sea
D90-60



ebony
10622-60

Laminate Fenix NTM®

FENIX NTM

Available decor sizes laminate Fenix NTM



300 x 150 cm
Laminated tops Fenix NTM.

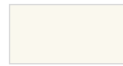

bianco kos
0032



verde comodoro
0750



blu fes
0754



rosso jaipur
0751



cacao orinoco
0749



grigio antrim
0752



grigio bromo
0724



nero ingo
0720

Types of lipping

1 2

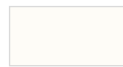

ABS snow white

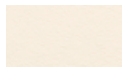

ABS white²



ABS maple²



ABS beech²



ABS oak



ABS shadow nut



ABS silver grey²



ABS soft grey



ABS north sea



ABS ebony



ABS black

6 8



massive beech³

30 31

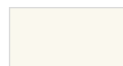

PP bianco kos



PP verde comodoro



PP blu fes



PP rosso jaipur



PP cacao orinoco



PP grigio antrim



PP grigio bromo

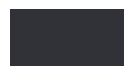

PP nero ingo



¹ Also available in low flammability finish.

² Antibacterial coating

³ Optionally standard stain (HPL top)

Table tops



D 18.0 kg/m²

FSP-HPL / 27 mm
Core: 3-layered chipboard with a laminate finish (HPL or Fenix NTM).



E 17.5 kg/m²

FSP-FU / 27 mm
Core: 3-layered chipboard with a high-grade wooden veneer finish.



J 20.5 kg/m²

MDF-HPL / 27 mm
Core: medium density fibreboard with a laminate finish (HPL or Fenix NTM).



K 20.0 kg/m²

MDF-FU / 27 mm
Core: medium density fibreboard with a high-grade wooden veneer finish.

Lippings



1
KK2 / 2 mm
2 mm plastic ABS.



2
FA2 / 2 mm
2 mm plastic ABS on MDF,
50 mm chamfered lipping.



6
HK2 / 2 mm
2 mm wood.



8
FB2 / 2 mm
2 mm wood on MDF,
50 mm chamfered lipping.





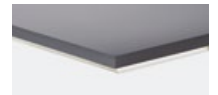







30
KK1 / 1 mm
1 mm plastic PP.



31
FA1 / 1 mm
1 mm plastic PP on MDF,
50 mm chamfered lipping.

Which table top, which lipping?

This chart gives an overview of all combinations which are technically possible.

| |  |  |  |  |  |  |
|--|---|---|---|---|---|---|
| | 1 | 2 | 6 | 8 | 30 | 31 |
|  D | • | | • | | • | |
|  E | | | • | | | |
|  J | | • | | • | | • |
|  K | | | | • | | |

Solutions, quality, sustainability

Excerpt

Fire Prevention

Depending on the environment, contract seating has to be able to fulfil very specific requirements. Interior designers and planners sometimes have to clear difficult hurdles: such as exacting fire prevention regulations. Kusch+Co has worked out individual solutions:

Wooden parts

As standard, wooden parts as well as high-grade wooden veneer finishes and high-grade wooden veneer lippings are protected by a UV curing, environmentally harmless, water-based lacquer meeting all the requirements of "low flammability" acc. to DIN EN 13501 B s2 d0.

Table tops

Table tops with a 3-layered chipboard core, and featuring either a HPL or real wood veneer surface are also available in a low flammability finish.

Please contact us if you wish to receive the test reports.

Please contact us to receive further information.

All the power and data modules feature safety-tested components bearing the VDE mark. All tables with power and data modules meet the requirements of the European Directives, standards and regulations currently in effect. The components are all fitted, tested, labelled, and documented by skilled and trained personnel.

We are certified in compliance with DIN EN ISO 9001:2015. In our own laboratory, we test our products before their market launch whether they comply with the normative requirements applicable to contract seating, task chairs, and tables, and issue a Declaration of Conformity.

We happily make these Declarations of Conformity as well as our brochure "Mission Statement Quality" providing detailed information on our test procedures available to you – please contact us.



Sustainability

Kusch+Co products stand for long life cycles and optimum recyclability. From the first design drafts of a new product, we take all environmental-relevant components and production processes into consideration, ranging from the materials selection and the design all the way to the manufacturing processes which also contribute towards our sustainable energy balance.

Environmental Product Declarations are available for all series, in accordance with DIN EN ISO 14021 Type II, providing more information about all environmentally relevant aspects, including the Credit Points for the LEED certification of a building. Please contact us for more information.

Quality

Our environmental and quality management systems are certified acc. to DIN EN ISO 14001:2015 and to DIN EN ISO 9001:2015.

External audits as well as our in-house laboratory safeguard our quality level.

The tables of series 6800 Creva desk meet the requirements with regard to stability, static and dynamic load as well as strength and durability in compliance with the current European Directives, standards and regulations.

On top of this, we voluntarily test the strength of our table frames with an additional horizontal load test using higher weights and more test cycles.

Environmental Product Declaration

In accordance with ISO 14021, type II

KUSCH+CO
by Henry Gyll

6800 Creva desk

Environmental aspects

Environmental responsibility

Long before the production of a new series, Kusch+Co starts thinking about the possible environmental impact of the production processes and the required components.

Sustainability

Kusch+Co understands sustainability as the realistic, measurable and economically viable contribution of environmental protection, economics and CSR, not only in terms of production, but also how we cooperate with our fellow firms, our staff members and partners. Sustainability cannot be measured, but it can be assessed. We live and breathe sustainability across all divisions. In accordance with our environmental guidelines, when creating the technical drawings, we label all recyclable plant parts accordingly, adding material deep marks, recycling code and date stamp in order to assure correct sorting and recyclability. Our environmental objectives are set and pursued within the framework of the mandatory energy audits in compliance with ISO 50000. We voluntarily align our operations and strategies with the ten universally accepted Global Compact Principles.

Quality assurance

In order to guarantee a constant high-level product quality, Kusch+Co is certified in accordance with the quality management system DIN EN ISO 9001:2015 and the environmental management system DIN EN ISO 14001:2015. We offer a 5-year warranty as standard. We adhere to and assure the compliance with all requirements laid down in ISO 45000 Occupational Health and Safety.

Life Cycle

Materials

- The models of series 6800 Creva desk are free from hazardous materials (lead, mercury, PVC).
- All components of series 6800 Creva desk comply with the high FSC standards.
- All our surfaces and materials are exempt of substances included on the REACH candidate list and these substances do not exceed CLP or the REACH candidate weight.
- A separate Declaration of Conformity regarding the RoHS Regulation is available on request.

Environmental Product Declaration

In accordance with ISO 14021, type II

KUSCH+CO
by Henry Gyll

6800 Creva desk

Environmental aspects

| Material composition | 6800/G | 6800/E |
|------------------------|--|--|
| Model | 300 x 100 cm, chipboard 27 mm, HPL, plastic-laying | 300 x 100 cm, chipboard 27 mm, HPL, plastic-laying |
| Weight | 54.7 kg | 105.6 kg |
| Dimensions (H x W x D) | 204 x 100 x 820 x 180 | 204 x 100 x 820 x 180 |
| Recyclable percentage | 27.8% | 27.9% |
| Recyclability | 99.0% | 99.2% |

These certificates prove the environmental and social compatibility of series 6800 Creva desk. At least 70% of the wood used in the production of this series is PEFC certified. Certificate No. 681020702G.

6800/G Rectangular high table, without top joint

300 x 100 cm, chipboard 27 mm, HPL, plastic-laying

6800/E Rectangular table, with top joint

400 x 180 cm, chipboard 27 mm, HPL, plastic-laying



